

# ULTRA-LOW POWER OSCILLATOR

## SERIES „ULPO-RB2“

### FEATURES

- + Ultra-Low Power Oscillator for Low Cost
- + Excellent long time reliability
- + Pin-compatible to 2012 XTAL SMD packaging
- +  $\pm 20$  ppm frequency tolerance at 25°C
- + Ultra-low power:  $< 1 \mu\text{A}$
- + Supports coin-cell or super-cap battery backup voltages
- +  $V_{\text{DD}}$  supply range: 1.5V to 3.63V over  $-40^\circ\text{C}$  to  $+85^\circ\text{C}$
- + Oscillator output eliminates external load caps
- + Internal filtering eliminates external  $V_{\text{DD}}$  bypass cap
- + Pb-free, RoHS and REACH compliant / MSL1@260°

### APPLICATIONS

- + Smart Phones
- + Tablets
- + Health and Wellness Monitors
- + Fitness Watches
- + Sport Video Cams
- + Wireless Keypads
- + Ultra-Small Notebook PC
- + Pulse-per-Second (pps) Timekeeping
- + RTC Reference Clock
- + Battery Management Timekeeping
- + Wearables
- + IoT
- + GPS
- + Smart Metering
- + Home Automation

### GENERAL DATA

PARAMETER AND CONDITIONS	SYMBOL	MIN.	TYP.	MAX.	UNIT	CONDITION
<b>FREQUENCY</b>						
Fixed Output Frequency	F_out		32.768		kHz	
<b>FREQUENCY STABILITY</b>						
Frequency Tolerance <sup>[1]</sup>	F_tol			20	PPM	T <sub>A</sub> = 25°C, post reflow, V <sub>DD</sub> : 1.5V – 3.63V
Frequency Stability <sup>[2]</sup>	F_stab			75	PPM	T <sub>A</sub> = $-10^\circ\text{C}$ to $+70^\circ\text{C}$ , V <sub>DD</sub> : 1.5V – 3.63V
				100	PPM	T <sub>A</sub> = $-40^\circ\text{C}$ to $+85^\circ\text{C}$ , V <sub>DD</sub> : 1.5V – 3.63V
				250	PPM	T <sub>A</sub> = $-10^\circ\text{C}$ to $+70^\circ\text{C}$ , V <sub>DD</sub> : 1.2V – 1.5V
25°C Aging		-1		1	PPM	1st Year
<b>OPERATING TEMPERATURE RANGE</b>						
Operating Temperature Range	T_use	-10	-	+70	°C	Commercial
		-40	-	+85	°C	Industrial
Storage Temperature Range	T_stor	-55	-	+125	°C	Storage
<b>SUPPLY VOLTAGE AND CURRENT CONSUMPTION</b>						
Operating Supply Voltage	V <sub>DD</sub>	1.2		3.63	V	T <sub>A</sub> = $-10^\circ\text{C}$ to $+70^\circ\text{C}$
		1.5		3.63	V	T <sub>A</sub> = $-40^\circ\text{C}$ to $+85^\circ\text{C}$
Core Operating Current <sup>[3]</sup>	I <sub>DD</sub>		0.90		$\mu\text{A}$	T <sub>A</sub> = 25°C, V <sub>DD</sub> : 1.8V. No load
				1.3	$\mu\text{A}$	T <sub>A</sub> = $-10^\circ\text{C}$ to $+70^\circ\text{C}$ , V <sub>DD</sub> max: 3.63V. No load
				1.4	$\mu\text{A}$	T <sub>A</sub> = $-40^\circ\text{C}$ to $+85^\circ\text{C}$ , V <sub>DD</sub> max: 3.63V. No load
Output Stage Operating Current <sup>[3]</sup>	I <sub>DD_out</sub>		0.065	0.125	$\mu\text{A}/\text{Vpp}$	T <sub>A</sub> = $-40^\circ\text{C}$ to $+85^\circ\text{C}$ , V <sub>DD</sub> : 1.5V – 3.63V. No load
Power-Supply Ramp	t_V <sub>DD_Ramp</sub>			100	ms	T <sub>A</sub> = $-40^\circ\text{C}$ to $+85^\circ\text{C}$ , 0 to 90% V <sub>DD</sub>
Start-up Time at Power-up <sup>[4]</sup>	t_start		180	300	ms	T <sub>A</sub> = $-40^\circ\text{C} \leq T_A \leq +50^\circ\text{C}$ , valid output
				450	ms	T <sub>A</sub> = $+50^\circ\text{C} < T_A \leq +85^\circ\text{C}$ , valid output

Notes: 1. Measured peak-to-peak. Tested with Agilent 53132A frequency counter. Due to the low operating frequency, the gate time must be  $\geq 100$  ms to ensure an accurate frequency measurement.

2. Stability is specified for two operating voltage ranges. Stability progressively degrades with supply voltage below 1.5V. Measured peak-to-peak. Inclusive of Initial Tolerance at 25°C, and variations over operating temperature, rated power supply voltage and load.

3. Core operating current does not include output driver operating current or load current. To derive total operating current (no load), add core operating current +  $(0.065 \mu\text{A}/\text{V}) \cdot (\text{peak-to-peak output Voltage swing})$ .

4. Measured from the time V<sub>DD</sub> reaches 1.5V.

## GENERAL DATA (continued)

PARAMETER AND CONDITIONS	SYMBOL	MIN.	TYP.	MAX.	UNIT	CONDITION
STANDARD LVCMOS OUTPUT OPTION, T <sub>A</sub> = -40°C TO +85°C, TYPICAL VALUES ARE AT T <sub>A</sub> = 25°C						
Output Rise/Fall Time	tr, tf		100	200	ns	10-90% (V <sub>DD</sub> ), 15 pF load, V <sub>DD</sub> = 1.5V to 3.63V
				50		10-90% (V <sub>DD</sub> ), 5 pF load, V <sub>DD</sub> ≥ 1.62V
Output Clock Duty Cycle	DC	48		52	%	
Output Voltage High	VOH	90%			0.9xV <sub>DD</sub>	V <sub>DD</sub> : 1.5V – 3.63V. I <sub>OH</sub> = -10 µA, 15 pF
Output Voltage Low	VOL			10%	0.1xV <sub>DD</sub>	V <sub>DD</sub> : 1.5V – 3.63V. I <sub>OL</sub> = 10 µA, 15 pF
PROGRAMMABLE, REDUCED SWING OUTPUT (ADAPTABLE TO CUSTOMER REQUIREMENT, FACTORY PROGRAMMED)						
Output Rise/Fall Time	tr, tf			200	ns	30-70% (V <sub>OL</sub> /V <sub>OH</sub> ), 10 pF Load
Output Clock Duty Cycle	DC	48		52	%	
AC-coupled Programmable Output Swing	V <sub>sw</sub>		0.20 to 0.80		V	ULPO-RB2 does not internally AC-couple. This output description is intended for a receiver that is AC-coupled. See Table 2 for acceptable swing options. V <sub>DD</sub> : 1.5V – 3.63V, 10 pF Load, I <sub>OH</sub> / I <sub>OL</sub> = ±0.2 µA.
DC-Biased Programmable Output Voltage High Range	VOH		0.60 to 1.225		V	V <sub>DD</sub> : 1.5V – 3.63V. I <sub>OH</sub> = -0.2 µA, 10 pF Load. See Table 1 for acceptable VOH/VOL setting levels.
DC-Biased Programmable Output Voltage Low Range	VOL		0.35 to 0.80		V	V <sub>DD</sub> : 1.5V – 3.63V. I <sub>OL</sub> = 0.2 µA, 10 pF Load. See Table 1 for acceptable VOH/VOL setting levels.
Programmable Output Voltage Swing Tolerance		-0.055		0.055	V	T <sub>A</sub> = -40°C to +85°C, V <sub>DD</sub> = 1.5V to 3.63V.
Period Jitter	T <sub>jitt</sub>		35		n <sub>RMS</sub>	Cycles = 10,000, T <sub>A</sub> = 25°C, V <sub>DD</sub> = 1.5V – 3.63V
EXCELLENT RELIABILITY DATA						
MTBF						500 million hours
Shock Resistance						10.000 g
Vibration Resistance						70 g

## PIN DESCRIPTION

SMD Pin	Symbol	I/O	Functionality
1	GND	Power Supply Ground	No Connect. Will not respond to any input signal. When interfacing to an MCU's XTAL input pins, this pin is typically connected to the receiving IC's X Out pin. In this case, the ULPO-RB2 will not be affected by the signal on this pin. If not interfacing to an XTAL oscillator, leave pin 1 floating (no connect).
2	GND	Power Supply Ground	
3	CLK Out	OUT	Oscillator clock output. When interfacing to an MCU's XTAL, the CLK Out is typically connected to the receiving IC's X IN pin. The ULPO-RB2 oscillator output includes an internal driver. As a result, the output swing and operation is not dependent on capacitive loading. This makes the output much more flexible, layout independent, and robust under changing environmental and manufacturing conditions.
4	V <sub>DD</sub>	Power Supply	Connect to power supply 1.5V ≤ V <sub>DD</sub> ≤ 3.63V for operation over -40°C to +85°C temperature range. Under normal operating conditions, V <sub>DD</sub> does not require external bypass/decoupling capacitor (s). Internal power supply filtering will reject more than ±150 mVpp with frequency components through 10 MHz. Contact Petermann-Technik for applications that require a wider operating supply voltage range.

FIGURE 1. SMD PACKAGE (TOP VIEW)

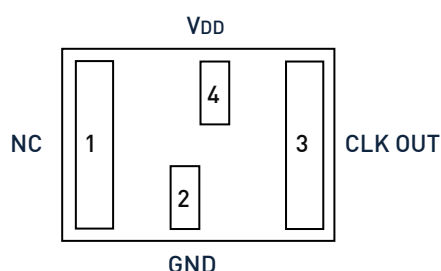

## DESCRIPTION

The ULPO-RB2 is an ultra-small and ultra-low power 32.768 kHz oscillator optimized for mobile and other battery-powered applications. The ULPO-RB2 is pin-compatible and footprint compatible to existing 2.0x1.2mm 32.768 kHz XTALs when using the recommended solder pad layout. And unlike standard oscillators, the ULPO-RB2 features a factory programmable output that reduces the voltage swing to minimize power.

The 1.2V to 3.63V operating supply voltage range makes it an ideal solution for mobile applications that incorporate a low-voltage, battery-back-up source such as a coin-cell or super-cap.

### XTAL FOOTPRINT COMPATIBILITY (SMD PACKAGE)

The ULPO-RB2 is a replacement to the 32.768 kHz XTAL in the 2.0x1.2 mm (2012) package. Unlike XTAL resonators, the ULPO-RB2 oscillators requires a power supply (VDD) and ground (GND) pin. VDD and GND pins are conveniently placed between the two large XTAL pins. When using the recommended solder pad layout (SPL), the ULPO-RB2 footprint is compatible with existing 32.768 kHz XTALs in the SMD package 2.0x1.2mm. Figure 3 shows the comparison between the quartz XTAL footprint and the ULPO-RB2 footprint. For applications that require the smallest footprint solution, consider ULPO-RB1 XO available in a 1.2mm<sup>2</sup> housing.

FIGURE 3. ULPO-RB2 FOOTPRINT COMPATIBILITY WITH QUARTZ XTAL FOOTPRINT [5]

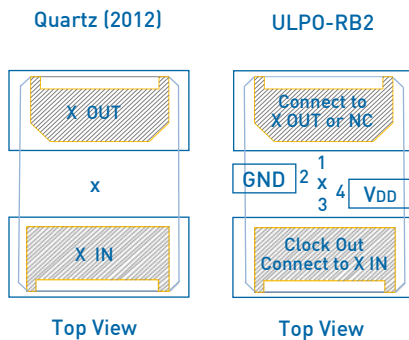

### FREQUENCY STABILITY

The ULPO-RB2 is factory calibrated to guarantee frequency stability to be less than  $\pm 20$  ppm at room temperature and less than  $\pm 100$  ppm over the full  $-40^{\circ}\text{C}$  to  $+85^{\circ}\text{C}$  temperature range. Unlike quartz crystals that have a classic tuning fork parabola temperature curve with a  $25^{\circ}\text{C}$  turnover point, the ULPO-RB2 temperature coefficient is extremely flat across temperature. The device maintains less than  $\pm 100$  ppm frequency stability over the full operating temperature range when the operating voltage is between 1.5 and 3.63V as shown in Figure 4.

Functionality is guaranteed over the 1.2V - 3.63V operating supply voltage range. However, frequency stability degrades below 1.5V and steadily degrades as it approaches the 1.2V minimum supply due to the internal regulator limitations. Between 1.2V and 1.5V, the frequency stability is  $\pm 250$  ppm max over temperature.

Note: 5. On the ULPO-RB2 device, X IN is not internally connected and will not respond to any signal. It is acceptable to connect to chipset X OUT.

When measuring the ULPO-RB2 output frequency with a frequency counter, it is important to make sure the counter's gate time is  $> 100\text{ms}$ . The slow frequency of a 32 kHz clock will give false readings with faster gate times.

For applications that require a wider supply voltage range  $> 3.63\text{V}$ , or operating frequency below 32.768 kHz, please consult Petermann-Technik.

FIGURE 4. ULPO-RB2 vs. QUARTZ

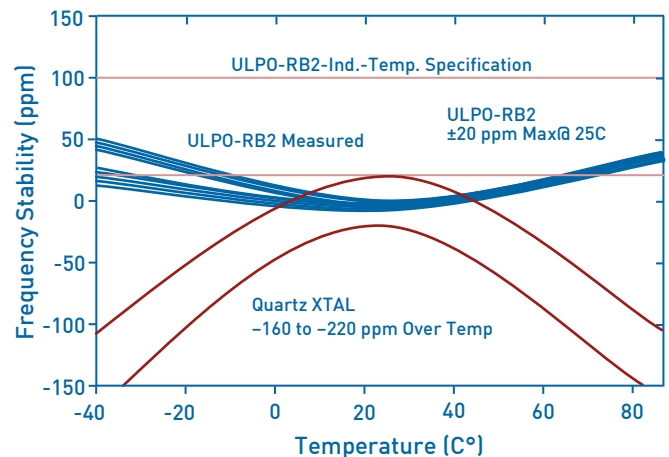

### POWER SUPPLY NOISE IMMUNITY

In addition to eliminating external output load capacitors common with standard XTALs, this device includes special power supply filtering and thus, eliminates the need for an external VDD bypass-decoupling capacitor. This feature further simplifies the design and keeps the footprint as small as possible. Internal power supply filtering is designed to reject AC-noise greater than  $\pm 150$  mVpp magnitude and beyond 10 MHz frequency component.

### OUTPUT VOLTAGE

The ULPO-RB2 has two output voltage options. One option is a standard rail-to-rail DC-coupled LVCMOS output swing. The second option is the programmable reduced swing output allowing to reduce current and which is fully adaptable to customers requirement. Output swing is customer specific and programmed between 200 mV and 800 mV.

For DC-coupled applications, output  $V_{OH}$  and  $V_{OL}$  are individually factory programmed to the customers' requirement.  $V_{OH}$  programming range is between 600 mV and 1.225V in 100 mV increments. Similarly,  $V_{OL}$  programming range is between 350 mV and 800 mV. For example: a PMIC or MCU is internally 1.8V logic compatible, and requires a 1.2V  $V_{IH}$  and a 0.6V  $V_{IL}$ . Simply select ULPO-RB2 factory programming code to be "D14" and the correct output thresholds will match the downstream IC or MCU input requirements. Interface logic will vary by manufacturer and we recommend that you review the input voltage requirements for the input interface.

For DC-biased output configuration, the minimum  $V_{OL}$  is limited to 350mV and the maximum allowable swing ( $V_{OH} - V_{OL}$ ) is 750mV. For example, 1.1V  $V_{OH}$  and 400mV  $V_{OL}$  is acceptable, but 1.2V  $V_{OH}$  and 400 mV  $V_{OL}$  is not acceptable.

When the output is interfacing to an XTAL input that is internally AC-coupled, the ULPO-RB2 output can be factory programmed to match the input swing requirements. For example, if a IC or MCU input is internally AC-coupled and requires an 800mV swing, then simply choose the ULPO-RB2 programming code "AA8" in the part number. It is important to note that the ULPO-RB2 does not include internal AC-coupling capacitors. Please see the Part Number Ordering section at the end of the datasheet for more information about the part number ordering scheme.

#### POWER-UP

The ULPO-RB2 starts-up to a valid output frequency within 300 ms (150ms typ). To ensure the device starts-up within the specified limit, make sure the power-supply ramps-up in approximately 10 - 20ms (to within 90% of  $V_{DD}$ ). Start-up time is measured from the time  $V_{DD}$  reaches 1.5V. For applications that operate between 1.2V and 1.5V, the start-up time will be longer.

#### ULPO-RB2 PROGRAMMABLE OUTPUT SWING

Figure 4 shows a typical ULPO-RB2 output waveform (into a 10 pF load) when factory programmed for a 0.70V swing and DC bias ( $V_{OH}/V_{OL}$ ) for 1.8V logic:

#### EXAMPLE:

- + Programmable output swing part number coding: D14. Example part number: ULPO-RB2-18-2012-75-D-32.768kHz-T-D14
- +  $V_{OH} = 1.1V$ ,  $V_{OL} = 0.4V$  ( $V_{SW} = 0.70V$ )

FIGURE 5. ULPO-RB2 OUTPUT WAVEFORM (10 PF LOAD)

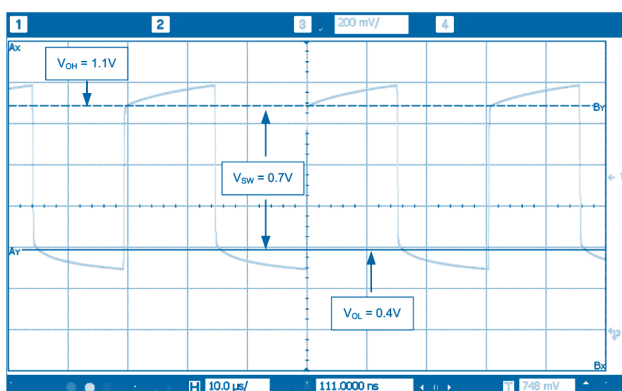

Table 1 shows the supported programmable output swing  $V_{OH}$ ,  $V_{OL}$  factory programming options.

TABLE 1. ACCEPTABLE  $V_{OH}/V_{OL}$  PROGRAMMABLE OUTPUT SWING LEVELS

VOL/VOH	1.225	1.100	1.000	0.900	0.800	0.700	0.600
0.800	D28	D18	D08				
0.700	D27	D17	D07	D97			
0.525	D26	D16	D06	D96	D86		
0.500	D25	D15	D05	D95	D85	D75	
0.400		D14	D04	D94	D84	D74	D64
0.350		D13	D03	D93	D83	D73	D63

Table 2 shows the supported AC coupled Swing levels. The "AC-coupled" terminology refers to the programming description for applications where the downstream chipset includes an internal AC-coupling capacitor, and therefore, only the output swing is important and  $V_{OH}/V_{OL}$  are not relevant.

TABLE 2. ACCEPTABLE AC-COUPLED SWING LEVELS

SWING	0.800	0.700	0.600	0.500	0.400	0.300	0.250	0.200
Output Code	AA8	AA7	AA6	AA5	AA4	AA3	AA2	AA1

#### EXAMPLE:

- + Programmable output swing part number coding: AA2. Example part number: ULPO-RB2-2012-75-D-32.768kHz-T-AA2
- + Output voltage swing: 0.250V

The values listed in Tables 1 and -2 are nominal values at 25°C and will exhibit a tolerance of  $\pm 55$  mV across  $V_{DD}$  and -40°C to 85°C operating temperature range.

#### ULPO-RB2 FULL SWING LVCMOS OUTPUT

The ULPO-RB2 can be factory programmed to generate full-swing LVCMOS levels. Figure 5 shows the typical LVCMOS waveform ( $V_{DD} = 1.8V$ ) at room temperature into a 15 pF load.

FIGURE 6. LVCMOS WAVEFORM ( $V_{DD} = 1.8V$ ) INTO 15 PF LOAD

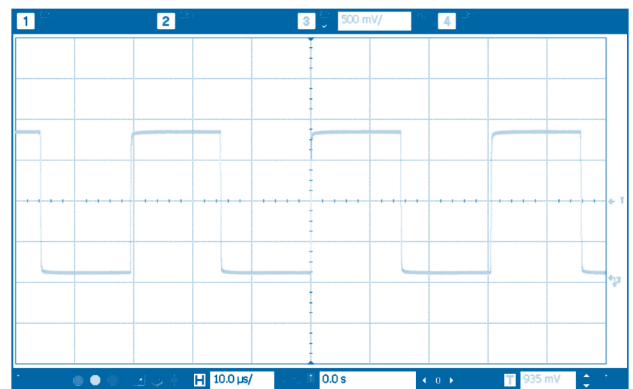

#### EXAMPLE:

- + LVCMOS output part number coding is always S (standard version)
- + Example part number: ULPO-RB2-33-2012-75-D-32.768kHz-T-S

## CALCULATING LOAD CURRENT

### NO LOAD SUPPLY CURRENT

When calculating no-load power for the ULPO-RB2, the core and output driver components need to be added. Since the output voltage swing can be programmed for reduced swing between 250 mV and 800 mV, the output driver current is variable. Therefore, no-load operating supply current is broken into two sections; core and output driver. The equation is as follows:

$$\text{Total Supply Current (no load)} = I_{DD} \text{ Core} + (65\text{nA/V})(V_{outpp})$$

#### EXAMPLE 1: FULL-SWING LVCMOS

- +  $V_{DD} = 1.8\text{V}$
  - +  $I_{DD} \text{ Core} = 900\text{nA (typ)}$
  - +  $V_{outpp} = 1.8\text{V (LVCMOS)}$
- $$\text{Supply Current} = 900\text{nA} + (65\text{nA/V})(1.8\text{V}) = 1017\text{nA}$$

#### EXAMPLE 2: PROGRAMMED REDUCED SWING

- +  $V_{DD} = 1.8\text{V}$
  - +  $I_{DD} \text{ Core} = 900\text{nA (typ)}$
  - +  $V_{outpp} \text{ (Programmable)} = V_{OH} - V_{OL} = 1.1\text{V} - 0.6\text{V} = 500\text{mV}$
- $$\text{Supply Current} = 900\text{nA} + (65\text{nA/V})(0.5\text{V}) = 932\text{nA}$$

### TOTAL SUPPLY CURRENT WITH LOAD

To calculate the total supply current, including the load, follow the equation listed below. Note the 30% reduction in power with programmable output swing.

$$\text{Total Current} = I_{DD} \text{ Core} + I_{DD} \text{ Output Driver } (65\text{nA/V} \cdot V_{outpp}) + \text{Load Current } (C \cdot V \cdot F)$$

#### EXAMPLE 1: FULL-SWING LVCMOS

- +  $V_{DD} = 1.8\text{V}$
- +  $I_{DD} \text{ Core} = 900\text{nA}$
- +  $\text{Load Capacitance} = 10\text{pF}$
- +  $I_{DD} \text{ Output Driver: } (65\text{nA/V})(1.8\text{V}) = 117\text{nA}$
- +  $\text{Load Current: } (10\text{pF})(1.8\text{V})(32.768\text{kHz}) = 590\text{nA}$
- +  $\text{Total Current} = 900\text{nA} + 117\text{nA} + 590\text{nA} = 1.6\mu\text{A}$

#### EXAMPLE 2: PROGRAMMED REDUCED SWING

- +  $V_{DD} = 1.8\text{V}$
- +  $I_{DD} \text{ Core} = 900\text{nA}$
- +  $\text{Load Capacitance} = 10\text{pF}$
- +  $V_{outpp} \text{ (Programmable): } V_{OH} - V_{OL} = 1.1\text{V} - 0.6\text{V} = 500\text{mV}$
- +  $I_{DD} \text{ Output Driver: } (65\text{nA/V})(0.5\text{V}) = 33\text{nA}$
- +  $\text{Load Current: } (10\text{pF})(0.5\text{V})(32.768\text{kHz}) = 164\text{nA}$
- +  $\text{Total Current} = 900\text{nA} + 33\text{nA} + 164\text{nA} = 1.1\mu\text{A}$

## TYPICAL OPERATING CURVES

FIGURE 7. INITIAL TOLERANCE HISTOGRAM

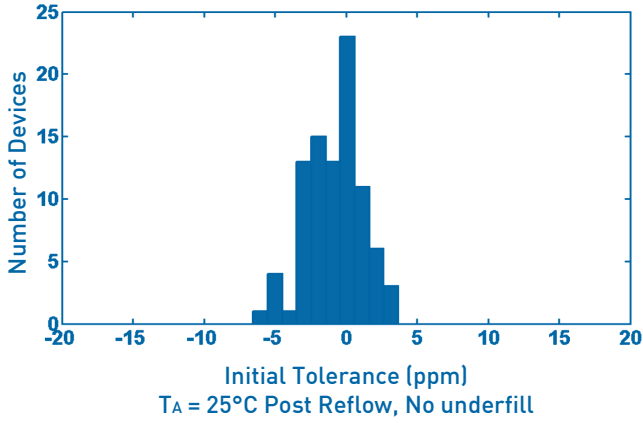

FIGURE 8. FREQUENCY STABILITY OVER TEMPERATURE

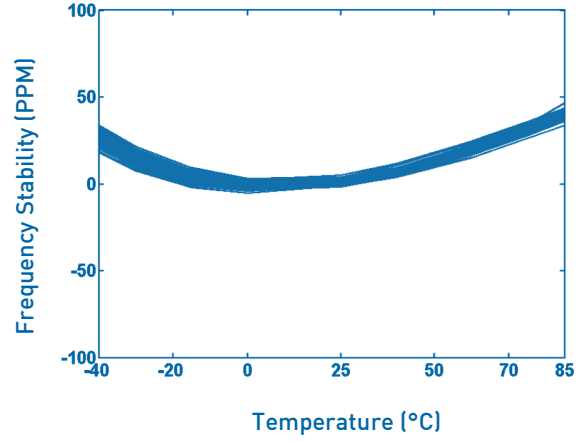

FIGURE 9. CORE CURRENT OVER TEMPERATURE

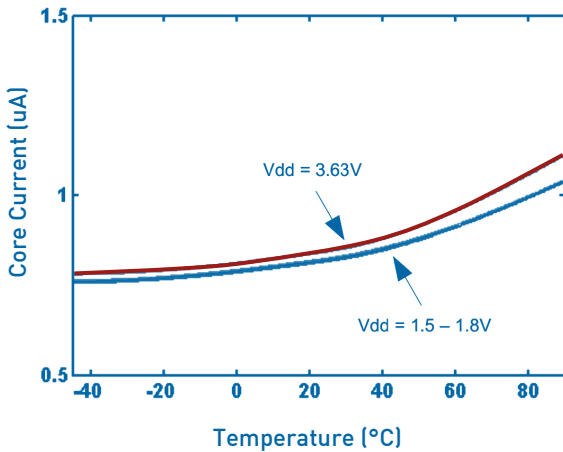

FIGURE 10. OUTPUT STAGE CURRENT OVER TEMPERATURE

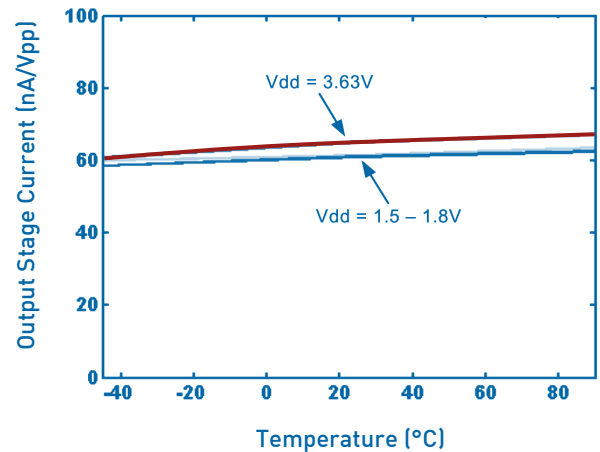
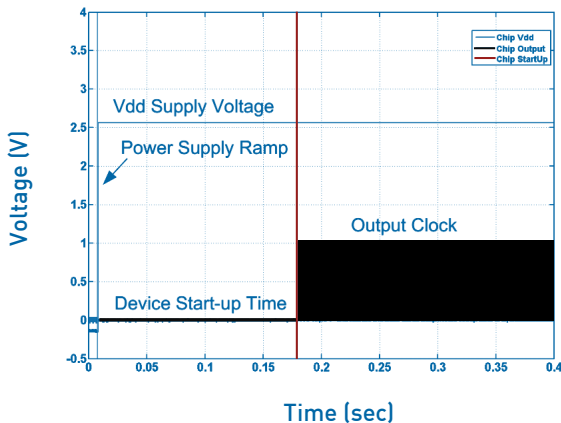

FIGURE 11. START-UP TIME



## TYPICAL OPERATING CURVES

FIGURE 12. POWER SUPPLY NOISE REJECTION (+/-150MV NOISE)

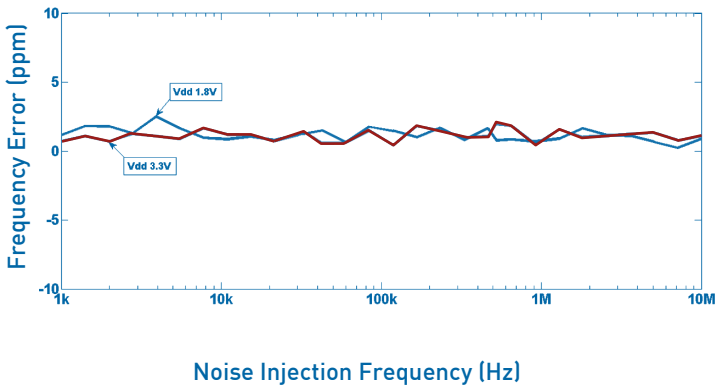

FIGURE 13. PROGRAMMABLE OUTPUT SWING WAVEFORM ( $V_{OH} = 1.1V$ ,  $V_{OL} = 0.4V$ ; ULPO-RB2)

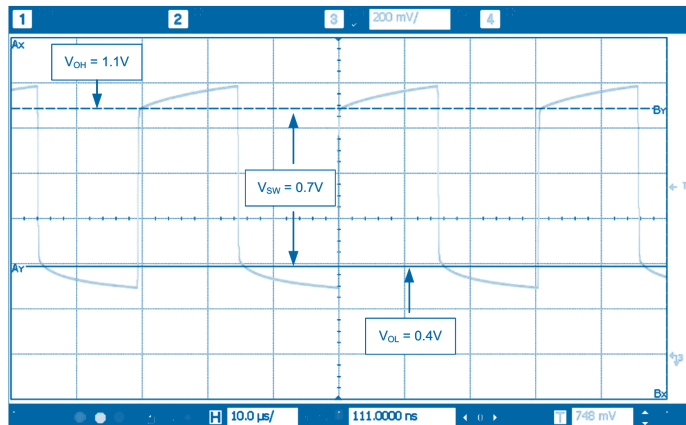
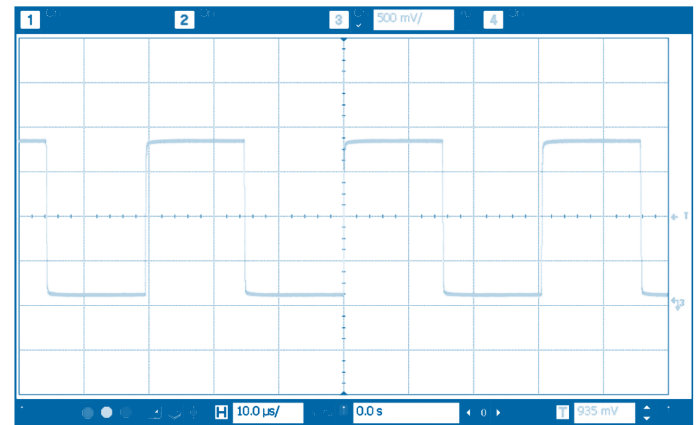

FIGURE 14. LVCMOS OUTPUT WAVEFORM ( $V_{SWING} = 1.8V$ , ULPO-RB2)



## DIMENSIONS AND PATTERNS

### PACKAGE SIZE - DIMENSIONS (UNIT:MM)

2.0 X 1.2 MM SMD

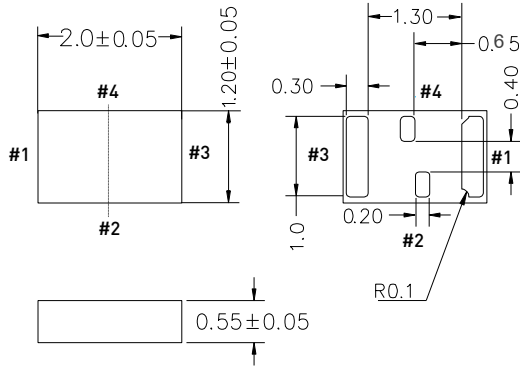

### RECOMMENDED LAND PATTERN (UNIT:MM)

ONLY SPL

XTAL COMPATIBLE SPL

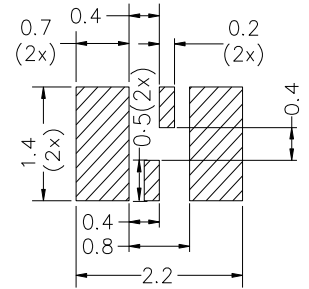
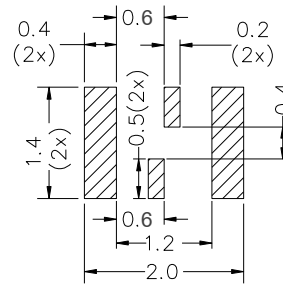

### REFLOW SOLDER PROFILE

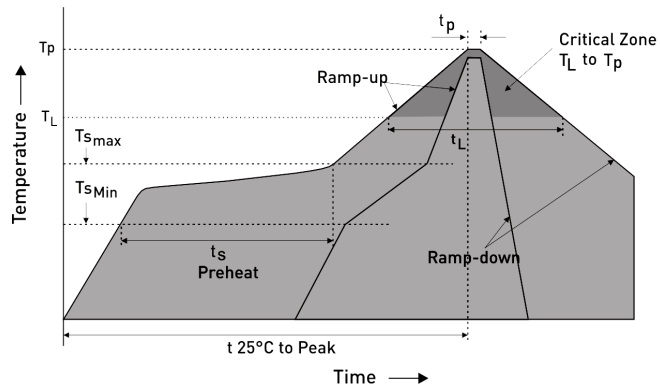

IPC/JEDEC Standard	IPC/JEDEC J-STD-020
Moisture Sensitivity Level	Level 1
TS MAX to TL (Ramp-up Rate)	3°C/second Maximum
Preheat	
- Temperature Minimum (TS MIN)	150°C
- Temperature Typical (TS TYP)	175°C
- Temperature Typical (TS MAX)	200°C
- Time (tS)	60 - 180 Seconds
Ramp-up Rate (TL to TP)	3°C/second Maximum
Time Maintained Above:	
- Temperature (TL)	217°C
- Time (TL)	60 - 150 Seconds
Peak Temperature (TP)	260°C Maximum
Target Peak Temperature (TP Target)	255°C
Time within 5°C of actual peak (tP)	20 - 40 Seconds
Max. Number of Reflow Cycles	3
Ramp-down Rate	6°C/second Maximum
Time 25°C to Peak Temperature (t)	8 minutes Maximum



## ORDERING INFORMATION

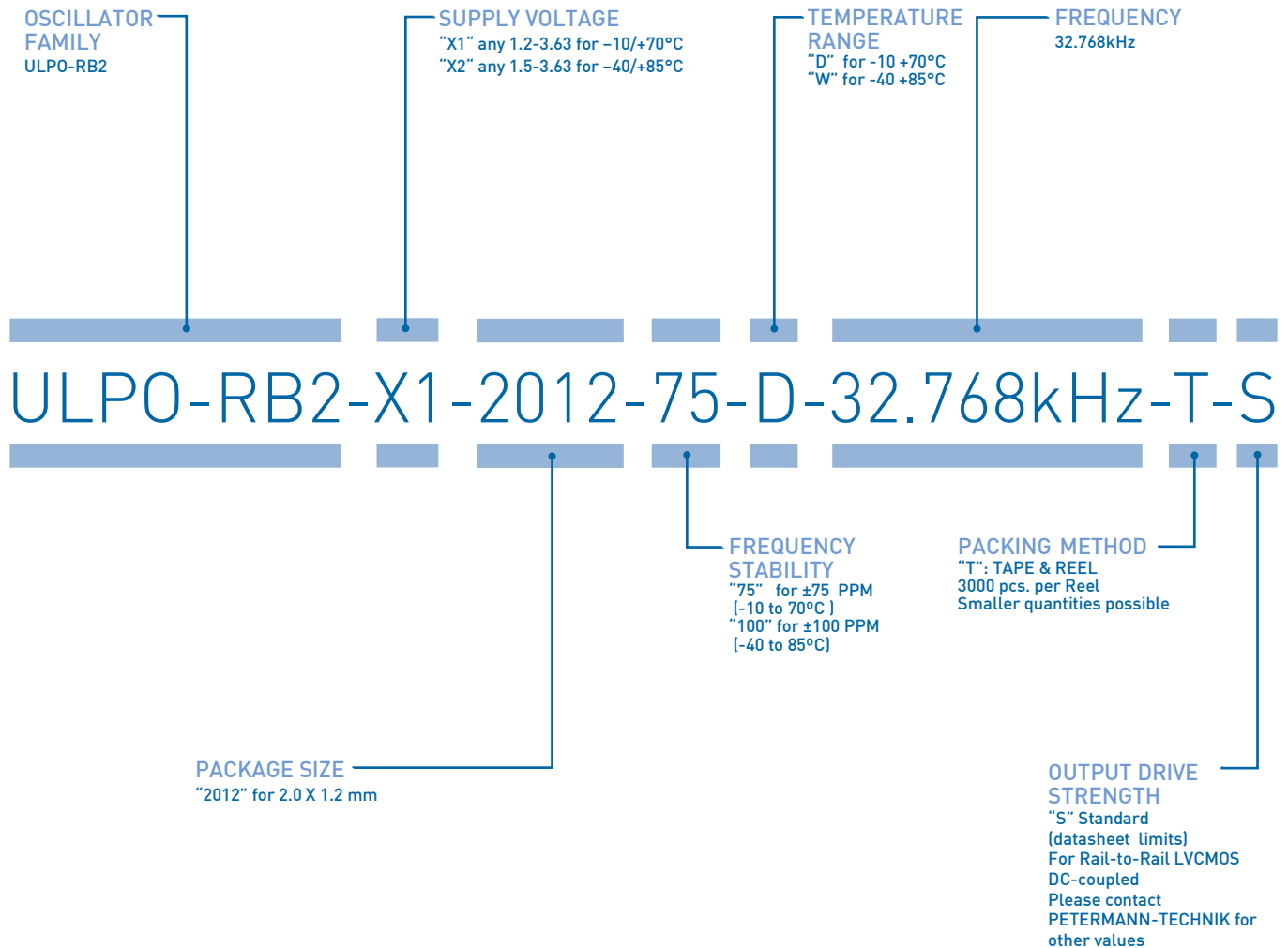

EXAMPLE: ULPO-RB2-X1-2012-75-D-32.768kHz-T-S

[PLEASE CLICK HERE TO CREATE YOUR OWN ORDERING CODE](#)

**EXPRESS SAMPLES ARE DELIVERABLE ON THE SAME DAY IF ORDERED UNTIL 02:00 PM!**



# PREMIUM QUALITY BY PETERMANN-TECHNIK



OUR COMPANY IS CERTIFIED ACCORDING TO ISO 9001:2015 IN OCTOBER 2016 BY THE DMSZ CERTIFIKATION GMBH.

THIS IS FOR YOU TO ENSURE THAT THE PRINCIPLES OF QUALITY MANAGEMENT ARE FULLY IMPLEMENTED IN OUR QUALITY MANAGEMENT SYSTEM AND QUALITY CONTROL METHODS ALSO DOMINATE OUR QUALITY STANDARDS.